

HBS-70N

外開き窓

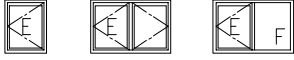

性能

耐風圧性:S-5

気密性:A-4

水密性:W-5

遮音性:T-2

枠タイプ:RC・ALC・同面

鉄骨外付・鉄骨半外付

ガラス溝巾:16mm

< RC >

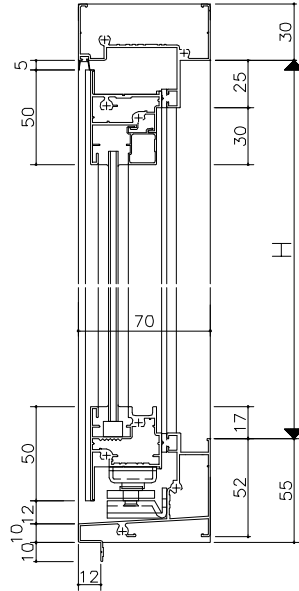

< 両開き召合わせ部 >

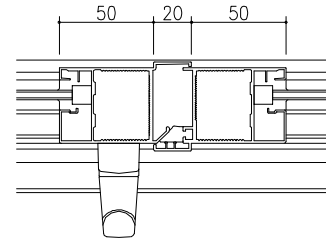

< 袖FIX部 >

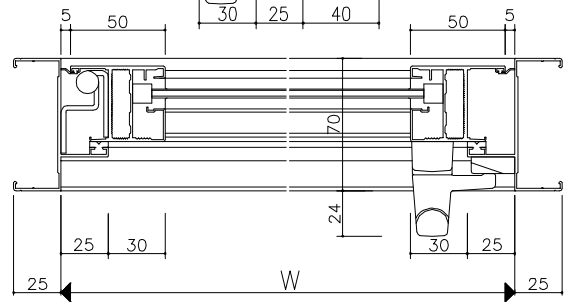
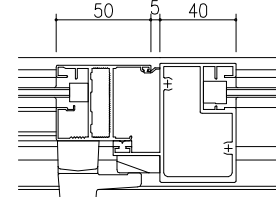

枠タイプ

< 同面 >

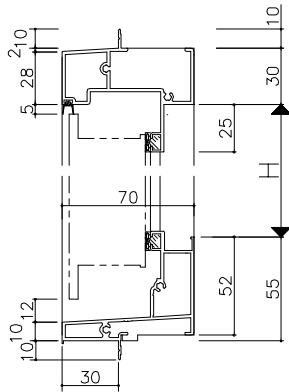

< ALC >

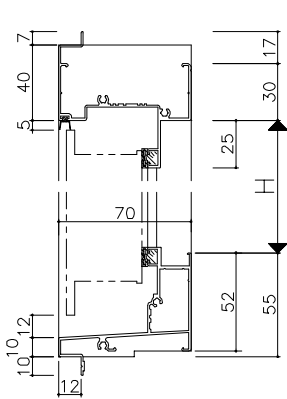

< 鉄骨半外付 >

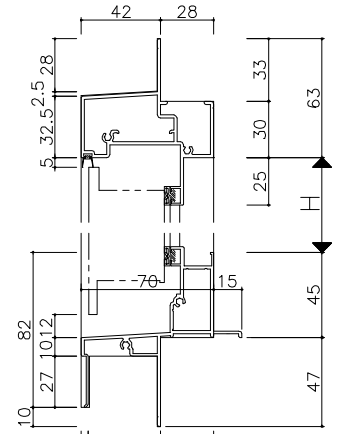

< 鉄骨外付 >

